

## Accessories

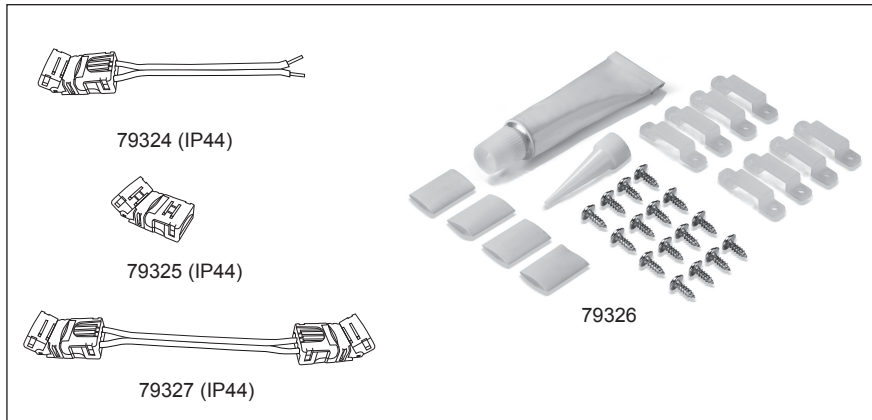

- For LED strips and connectors: just push together to connect - use supplied brackets to secure to mounting surface.
- Use the supplied silicone sealant and plastic sleeves to seal the connecting joints and ends of the LED strips to maintain IP44 protection. But LED strip are still IP65 protection.

## Care and Safety

- We recommend cleaning with a soft dry cloth. Do not use solvents or abrasive cleaners as these could damage the LED's.
- For your safety, always switch off the power supply before cleaning.

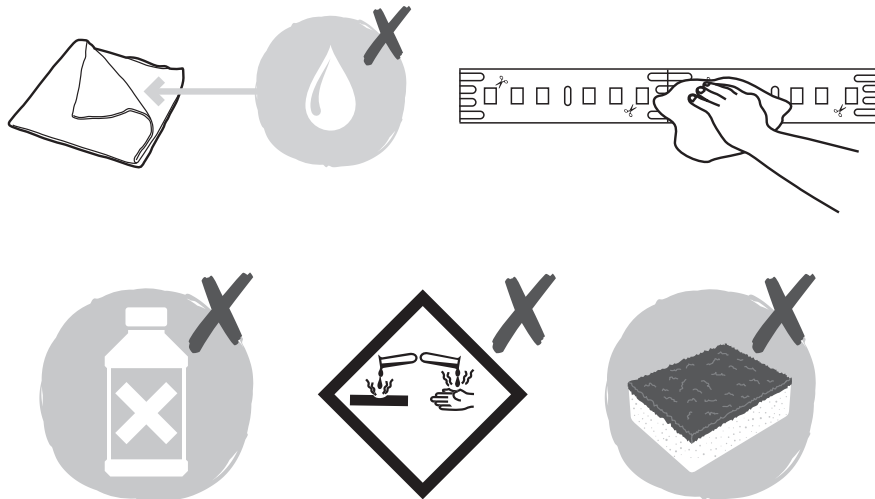

## Instruction leaflet

# Regen Tape 5m IP65

79317, 79318



CE

Thank you for purchasing this light fitting. Please read the instructions carefully before use to ensure safe and satisfactory operation of this product. Please retain these instructions for future reference.

## Warning

Please read these instructions carefully before commencing any work.

This unit must be fitted by a competent and qualified electrician.

Install in accordance with IEE Wiring regulations and current Building Regulations.

Check the pack and make sure you have all of the parts listed.

This system operates at Safety Extra Low Voltage (24V d.c.), via a LED driver. Never connect the LED strips directly to the mains without using the correct LED driver.

If replacing an existing fitting, make a careful note of the connections.

The mains plug must be situated indoors (e.g. house, garage, shed) in order to protect it from the elements.



Do not exceed the LED driver load. LED drivers may require a minimum load to operate.

Always unplug the LED driver from the mains when installing or maintaining this system.

This product contains non-replacable parts and cannot be serviced. If damage occurs the part should be scrapped.

This product can be dimmable when using dimmable driver.

## Technical data

Supply Voltage:	24V
Bulb Type:	79317: 55W LED SMD, 3300K 79318: 55W LED SMD, 4000K
	Conformity with all relevant EC Directive requirements.
	Waste electrical products should not be disposed of with household waste. Please recycle where facilities exist. Check with your Local Authority or local store for recycling advice.
	This is a Class 3 product and requires the use of a LED Driver (not supplied).
<b>IP65</b>	Jet - proof

## Layout

- The Regen LEDs are mounted on a sticky tape which can be stuck to most surfaces.
- The Regen LEDs can be shortened to a minimum of 100mm or multiples of 100mm.
- Plan the desired layout of this fitting carefully, ensuring the cables will reach the distance between the power supply and the Regen LEDs.
- Avoid locating any cables in positions that would cause a hazard. Position cables and Regen LEDs (not supplied) away from areas where they may be at risk from being cut, trapped or damaged.
- Cables in walls must be protected using suitable conduit or plastic trunking.

## Installation

- Position the LED driver next to the mains outlet socket that the system will connect to. Do not plug-in at this stage. Make sure that the LED driver used can load the total power of the LED strip.
- After deciding the layout of the LED strips, ensure the cables are long enough to connect to the desired positions.
- The unit can be easily shortened to whole metre lengths. To shorten the tape to a specific length, then it can be done in multiples of 100mm.
- Cut to the desired length. The maximum permissible length of 24V SMD LED's for each driver is listed. Ensure that the cut is made at the copper connection points.
- Before connect the Regen strip or the cable, must use the glue to connect, details refer to below **Figs.**
- Peel the backing tape off the Regen strip. Apply moderate pressure to stick the LED's to the surface. An assistant may be required to help stick longer lengths accurately.
- Connect the LED tape to the LED drive - ensuring You have correctly identified the wires. Rated constant input voltage when a luminaire is operated from a constant volotage controlgear not provided with the luminaire. Rated constant input current when the luminaire is operated from a constant current controlgear not provided with the luminaire. Luminaires supplied with constant current shall also be marked with the highest allowed U out value of the controlgear.
- Connect the power connector to the LED driver.
- Ensure that all the connections are tight
- Connect the power supply to the mains and turn on.
- **In order to ensure the life of the lamp belt. It is recommended to be used with our profile range. (80497 to 80501)**

Fig 1.

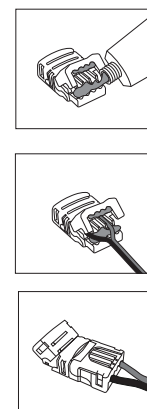

Fig 2.

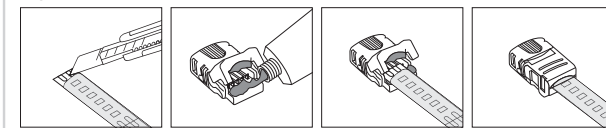

Fig 3.

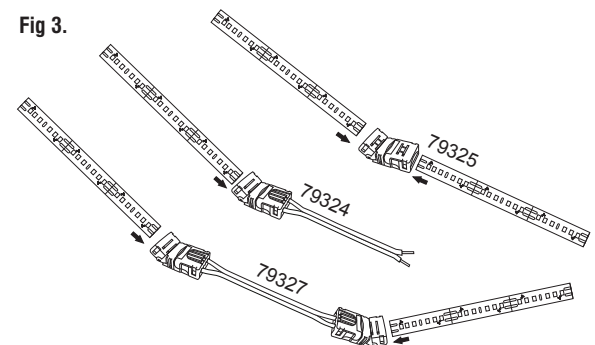

Fig 4.

